

PANTHER

RUGGEDIZED IP65/IP67/IP68/IP69K WATERPROOF

- Designed for use in rail, earth moving, battery and related applications
- Meets EN45545-2 HL3 (R22/R23) requirements



Positronic[®]
an Amphenol company

THE SCIENCE OF **CERTAINTY**[®]

M04 Rev A1 20/05



Positronic[®]

an Amphenol company

Positronic builds premium power and signal connectors for a variety of industries. But every product delivers a single outcome: *Certainty*.

Driven by the mission-critical needs of our customers, we've gone to school on the subject for over 50 years. We approach it with scientific discipline – honing the fusion of raw material, engineering ingenuity, and precision manufacturing to push the next limits of reliability.

And with every new project, our curiosity is reignited. How will certainty be achieved in your system, with its own unique demands? The answers have graced the most formidable missions of our time, from the fires of super-sonic flight to the merciless scapes of Mars.

WHAT CAN YOU BE CERTAIN ABOUT?

- Rock-solid reliability
- Maximum design flexibility
- High efficiency, low heat performance
- Responsive, knowledgeable support

THE SCIENCE
OF **CERTAINTY**[®]

TABLE OF CONTENTS

Overview

Family Overview	1
Series Comparison	1

Panther II

Overview	2
Tech Specs	2
Module Layouts	3
Dimensions	3
Contacts	4
Temperature Rise Curves	4
Create A Part	5



Panther I

Overview	6
Tech Specs	7
Contact Layouts	7
Dimensions	7
Create A Part	7
Contacts	8
Temperature Rise Curves	8
Accessories	9



The **Panther** family of products, consisting of the **PA Series** and the **PB Series**, are rugged, waterproof connectors built for demanding applications. When your project calls for high power, shock and vibration resistance, or needs to meet fire, smoke and toxicity requirements for passenger applications, the **Panther** family can meet your requirements. The connectors can be used reliably in operating temperatures up to 200°C and are rated up to IP69. Trust the **Panther** family of connectors to deliver a reliable connection in any harsh environment.

SERIES COMPARISONS

		POWER ONLY	POWER & SIGNAL	SIZE	IDEAL FOR
	<p>PANTHER I - PA series</p> <p>Rugged IP65/67/68/69K connector for use in rail, earth moving, battery and related applications</p>	x	x	Medium	IP65/67/68/69K power and signal needs
	<p>PANTHER II - PB series</p> <p>Large, high power, touch-safe connector for use in harsh environmental conditions</p>	x		Large	IP65/67/68/69K power and signal needs



The **Panther II** is designed for rugged, heavy duty applications where reliability cannot be comprised when operating in harsh environmental elements.

Panther II connectors are tested to meet rigorous salt spray, shock and vibration requirements. And when outdoor temperatures rise, the **Panther II** continues to provide a dependable connection, while resisting dust and water. If you need a reliable connector for your outdoor applications, **Panther II** delivers with its robust design, including a unique stainless steel locking mechanism for numerous mating cycles and trusted connections.

Trust the **Panther II** to deliver ***The Science of Certainty*** in mission-critical applications.

TECH SPECS

GENERAL

Part Number Prefix	PB
Performance Level	Mil/Aero Railway
Qualifications	UL*1 IEC safety standard Shock/Vibration testing standard EN45545-2 HL3 (R22) FAR 25.853 UV stability F1 grading Salt spray test

*1 UL approval for layout 03. Contact Technical Sales for UL status on other variants.

MATERIAL

Insulator Material	PEI
Insulator Color	Black
Flammability Rating	UL94 V-0
Contact Material	Copper alloy
Contact Plating	Gold flash 0.76µm Au 1.27µm Au

ELECTRICAL

Working Voltage (rms)	1600 V
Initial Contact Resistance (max)	0.38 mΩ
Contact Current Rating at 30°C Temperature Rise per UL1977*1	Up to 110A*2
Contact Current Rating per UL1977*1	Up to 230A*2

*1 See page 4 for temperature rise curves

*2 Value established using high conductivity alloy

MECHANICAL

Contact Style	Removable
Female Contact Design	Closed entry
Mating Cycles	500

ENVIRONMENTAL

Operating Temperature	-55 to 160°C
Waterproof	IP65 IP67 IP68 IP69K

To download detailed product information, visit www.connectpositronic.com/PantherII/ProductSpecs

MODULE LAYOUTS

Scale 1:1

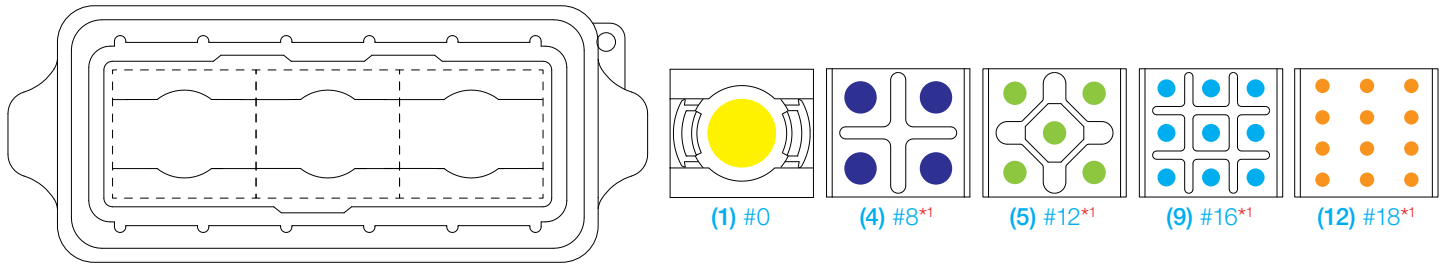

*1 Contact Technical Sales for availability

Contact Size Chart				
#0	#8	#12	#16	#18

All Positronic products utilize solid, machined contacts.

DIMENSIONS

For the sake of brevity, only basic dimensions of free cable male are shown here. Full dimensional detail is available in the respective product drawings.

Scale 1:1

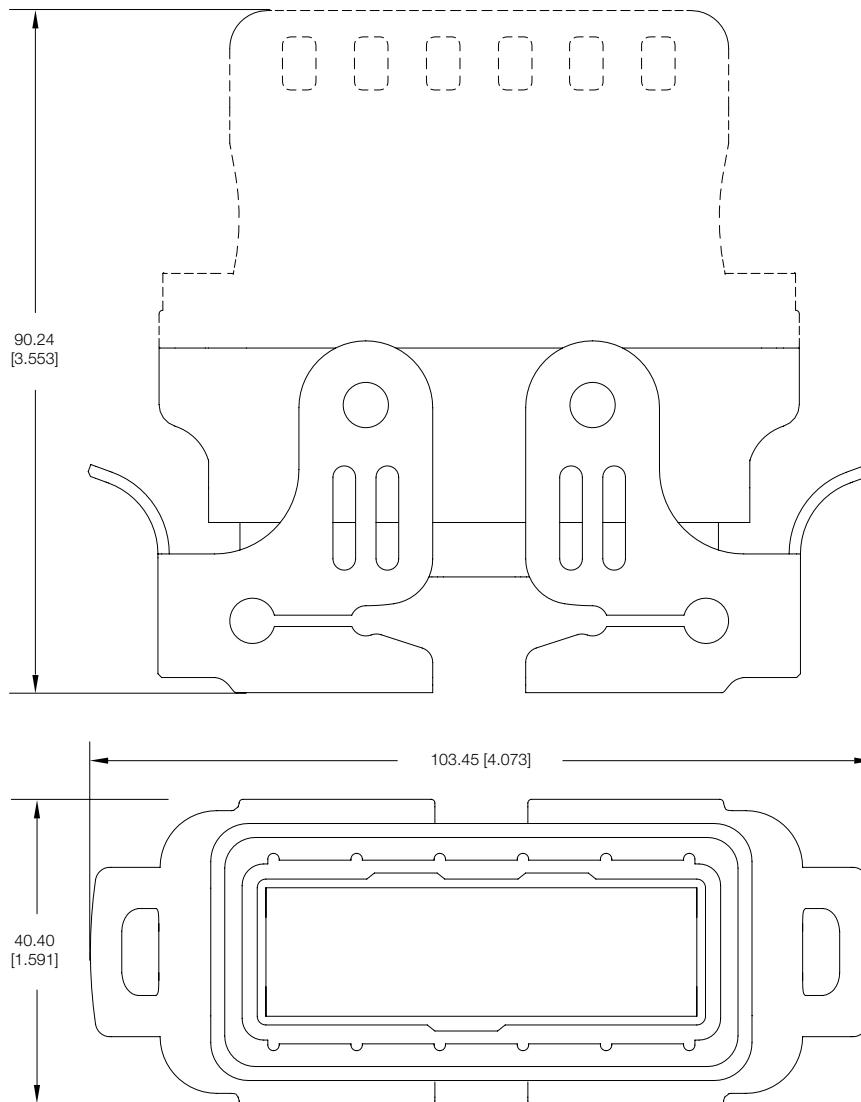

CONTACTS

Contact Technical Sales for crimp contact part numbers not listed here.

PART NUMBER	Size	Gender	Female Contact Style	Stranded AWG [mm ²]	
CN00-FXCRA-0001	SC	#0	Female	Closed entry	#0 [53.5]
CN00-FHCRA-0001	HC	#0	Female	Closed entry	#0 [53.5]
CN00-MXCRA-0001	SC	#0	Male	n/a	#0 [53.5]
CN00-MHCRA-0001	HC	#0	Male	n/a	#0 [53.5]

SC Standard conductivity contacts
HC High conductivity contacts

TEMPERATURE RISE CURVES

Tested per IEC Publication 60512-5-1, Test 5a

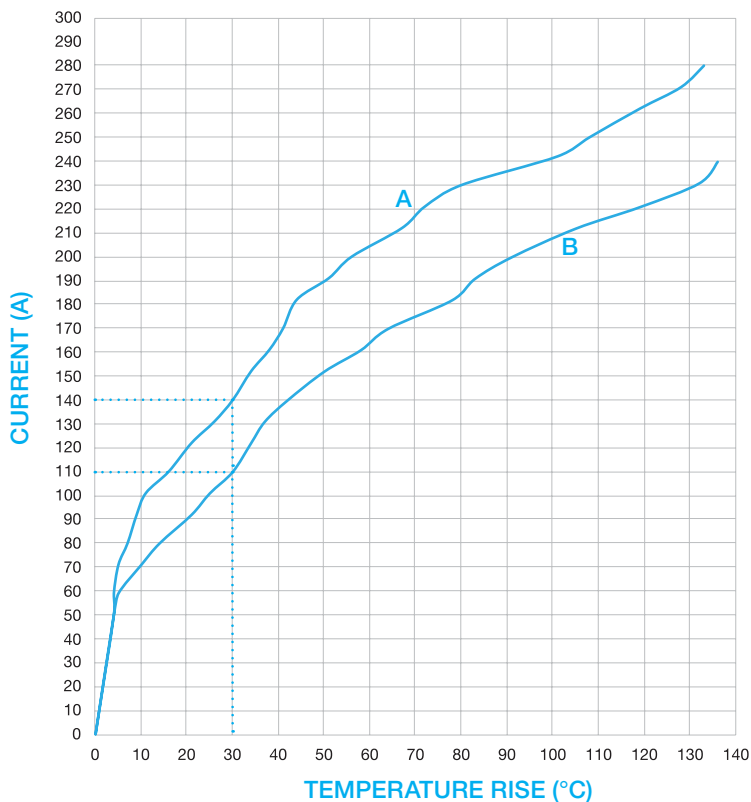

- A** Developed with (3) #0 high conductivity contacts with 0 AWG wire.
- B** Developed with (3) #0 standard conductivity contacts with 0 AWG wire.

CREATE A PART

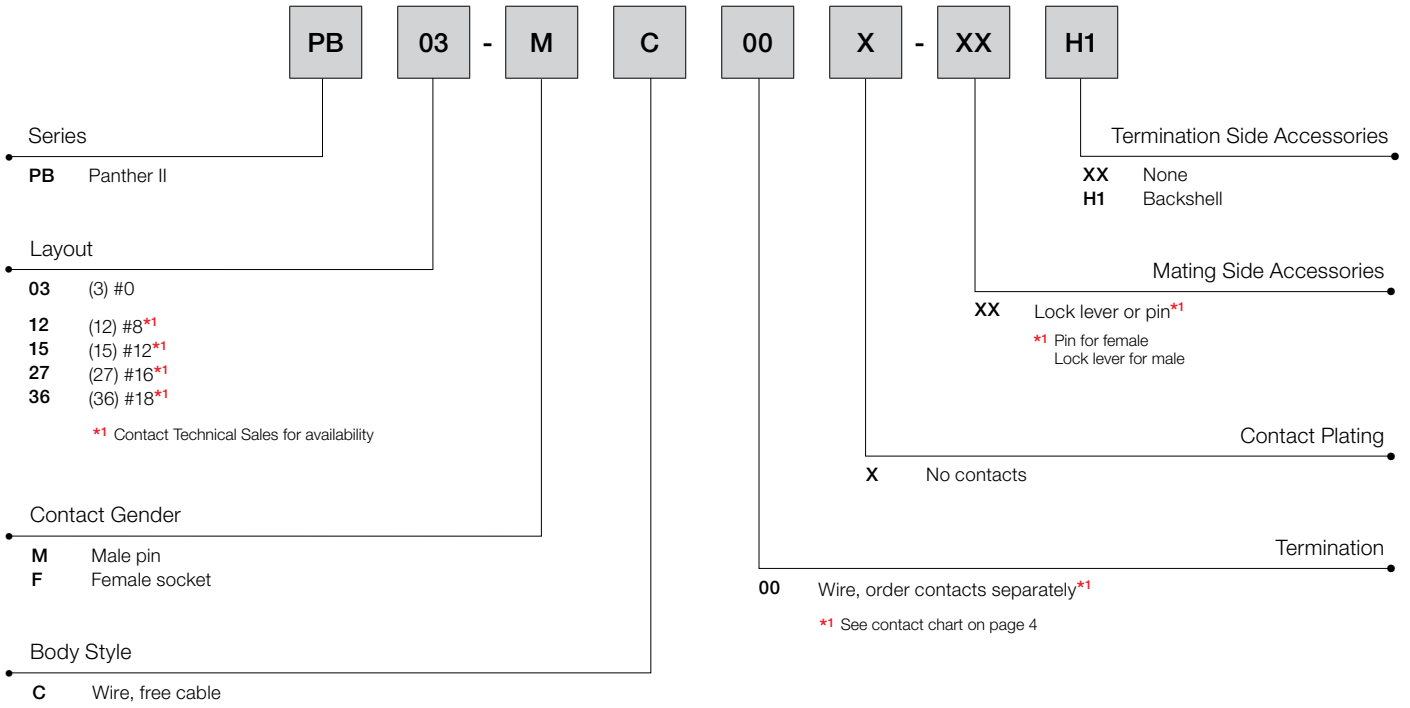



In the world of electronics, the ability of the equipment to withstand harsh environments is becoming increasingly critical. The **Panther I** addresses that need by offering up to IP69K sealing capability along with increased operating temperature ranges. It also meets smoke and toxicity requirements common in aerospace, rail and other passenger applications.

- IP65/IP67/IP68/IP69K in mated condition
- Operating temperatures up to 200°C
- Meets smoke and toxicity requirements

Trust the **Panther I** to deliver **The Science of Certainty** in mission-critical applications.

TECH SPECS

GENERAL

Part Number Prefix	PA
Performance Level	Industrial Mil/aero
Qualifications	UL*1 IEC safety standard Shock/Vibration testing standard EN45545-2 HL3 (R22/R23) FAR 25.853 NFF 16-101/102 Salt spray test

*1 UL approval for layouts 03 and 08. Contact Technical Sales for UL status on other variants.

MATERIAL

Insulator Material	LCP
Insulator Color	Black
Flammability Rating	UL94 V-0
Contact Material	Copper alloy
Contact Plating	Gold flash 0.76µm Au 1.27µm Au

ELECTRICAL

Working Voltage (rms)	1600 V	
Initial Contact Resistance (max)	5 mΩ	
Contact Current Rating at 30°C Temperature Rise*1	Power	Up to 45A*2
	Signal	Up to 5A
Contact Current Rating per UL 1977*1	Power	Up to 105A*2
	Signal	Up to 5A

*1 See page 8 for temperature rise curves

*2 Value established using high conductivity alloy

MECHANICAL

Contact Style	Fixed Removable
Female Contact Design	Closed entry
Mating Cycles	Up to 1000

ENVIRONMENTAL

Operating Temperature	-55 to 200°C
UV Protection	Rated (f1) per UL 746C
Waterproof	IP65 IP67 IP68 IP69K

To download detailed product information, visit www.connectpositronic.com/Panther/ProductSpecs

CONTACT LAYOUTS

Scale 1:1

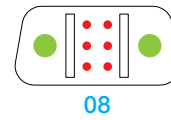
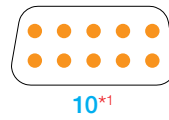
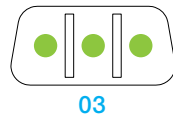
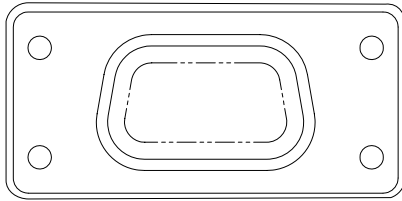

Contact Size Chart		
#12	#18	#22

All Positronic products utilize solid, machined contacts.

*1 Contact Technical Sales for availability

DIMENSIONS

For the sake of brevity, only basic dimensions of free cable male are shown here. Full dimensional detail is available in the respective product drawings.

Scale 1:1

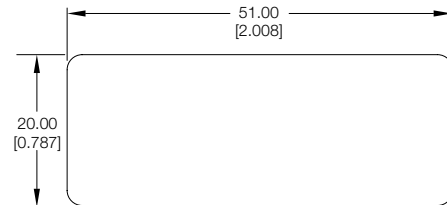
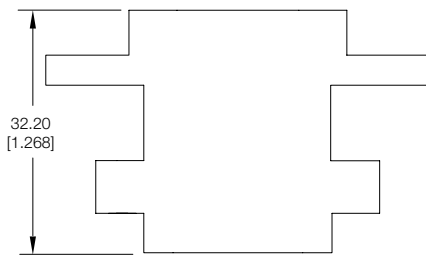

CREATE A PART

PA 03 - M C 00 X - E2 H1

- Series**
 - PA Panther I
- Layout**
 - 03 (3) #12
 - 08 (2) #12, (6) #22
 - 10 (10) #18*1

*1 Contact Technical Sales for availability
- Contact Gender**
 - M Male pin
 - S Female socket
- Body Style**
 - C Wire, free cable
 - P Panel mount (wire or PCB)
- Termination**
 - 00 Wire, order contacts separately*1
 - 30 Straight solder
 - 31 Straight solder, high conductivity alloy*2
 - 90 Straight press-fit*3
 - 40 Right angle solder
 - 41 Right angle solder, high conductivity alloy*2

*1 See contact chart on page 8
*2 High conductivity alloys are used on #18 contacts and larger
*3 Contact Technical Sales for availability
- Termination Side Accessories**
 - XX None
 - B1 Angle bracket (for use on right angle terminations)
 - H1 Backshell (for use with free cable)
- Mating Side Accessories**
 - XX None
 - T2 Fixed female jackposts (wire, free cable, panel mount and PCB mount)
 - E2 Rotating male jackscrews, low profile, slotted (wire, free cable)
- Contact Plating**
 - X No contacts
 - A Gold flash
 - C 0.76 µm [30µin] min Au over Ni

CONTACTS

Contact Technical Sales for crimp contact part numbers not listed here.

PART NUMBER		Size	Gender	Female Contact Style	Stranded AWG [mm ²]
FC1210P2/AA	SC	#12	Female	Closed entry	#10 [5.3]
FC1210P2S/AA	HC	#12	Female	Closed entry	#10 [5.3]
FC1212P2/AA	SC	#12	Female	Closed entry	#12 [4.0]
FC1212P2S/AA	HC	#12	Female	Closed entry	#12 [4.0]
MC1210N-PA563/AA	SC	#12	Male	n/a	#10 [5.3]
MC1210NS-PA563/AA	HC	#12	Male	n/a	#10 [5.3]
MC1212N-PA563/AA	SC	#12	Male	n/a	#12 [4.0]
MC1212NS-PA563/AA	HC	#12	Male	n/a	#12 [4.0]
FC1816P2/AA	SC	#18	Female	Closed entry	#16-18 [1.5-1.0]
FC1816P2S/AA	HC	#18	Female	Closed entry	#16-18 [1.5-1.0]
FC1820P2/AA	SC	#18	Female	Closed entry	#20 [0.5]
FC1820P2S/AA	HC	#18	Female	Closed entry	#20 [0.5]
MC1816N-PA561/AA	SC	#18	Male	n/a	#16-18 [1.5-1.0]
MC1816NS-PA561/AA	HC	#18	Male	n/a	#16-18 [1.5-1.0]
MC1820N-PA561/AA	SC	#18	Male	n/a	#20 [0.5]
MC1820NS-PA561/AA	HC	#18	Male	n/a	#20 [0.5]
FC422P9/AA	SC	#22	Female	Closed entry	#22-26 [0.30-0.12]
MC422N9-PA1007/AA	SC	#22	Male	n/a	#22-26 [0.30-0.12]

- SC** Standard conductivity contacts
- HC** High conductivity contacts

TEMPERATURE RISE CURVES

Tested per IEC Publication 60512-5-2, Test 5a

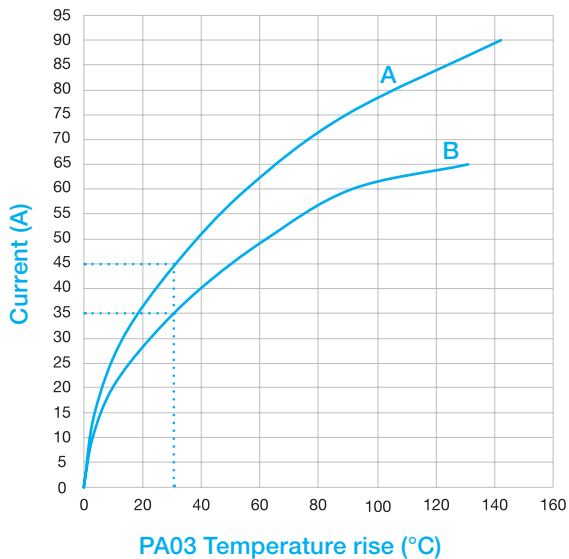

- A** Developed with (3) #12 high conductivity contacts with 10 AWG wire.
- B** Developed with (3) #12 standard conductivity contacts with 10 AWG wire.

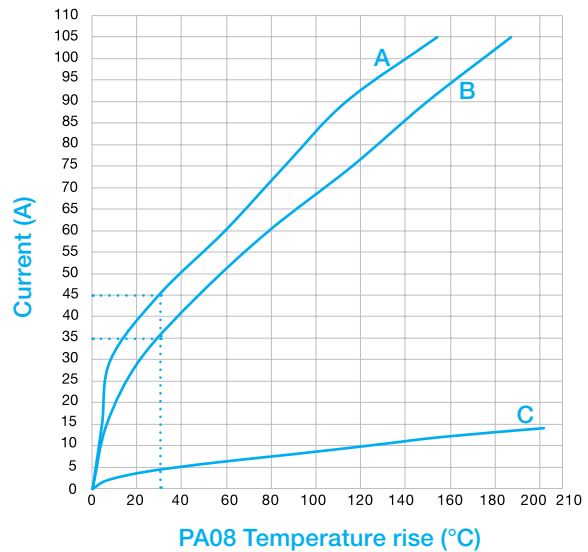

- A** Developed with (2) #12 high conductivity contacts with 10 AWG wire.
- B** Developed with (2) #12 standard conductivity contacts with 10 AWG wire.
- C** Developed with (2) #22 standard conductivity contacts with 22 AWG wire.

BACKSHELL

H1 (For use with wire termination)

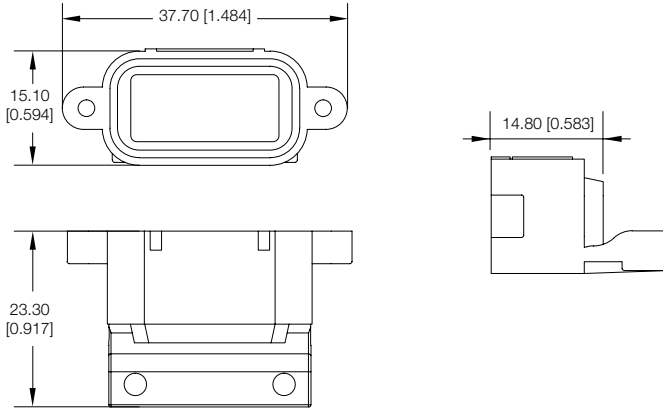

MATERIALS	
Backshell	LCP, black
Cable clamp	Stainless steel, passivated
Screws	Stainless steel, passivated



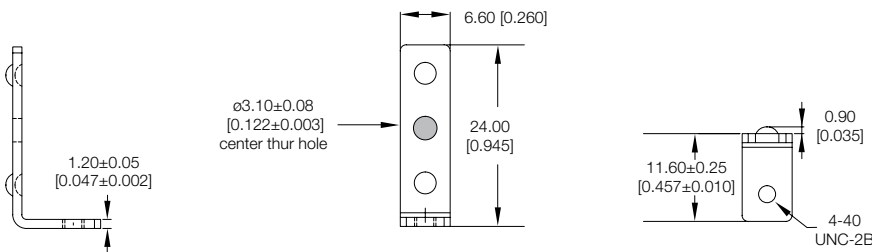
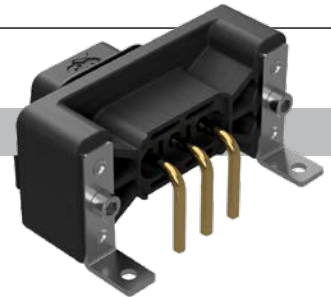

ANGLE BRACKET

B1 (For use with right angle)



MATERIALS	
Angle bracket	Stainless steel, passivated
Screws	Stainless steel, passivated

See connectpositronic.com/Panther for all other Panther-related information including:

- ✓ **Footprints** 
- ✓ **Tooling** 
- ✓ **Product updates** 
- ✓ **Detailed dimensions** 
- ✓ **2D/3D drawings** 

All dimensional tolerances are ± 0.38 [0.015], unless otherwise specified. Dimensions are in millimeter [inches]. All dimensions are subject to change. Product pictures may not be identical in appearance to actual production parts.

Information in this catalog is proprietary to Positronic and its subsidiaries. Positronic believes the data contained herein to be reliable. Since the technical information is given free of charge, the user employs such information at his own discretion and risk. Positronic assumes no responsibility for results obtained or damages incurred from use of such information in whole or in part.

The following trademarks are owned by Positronic Industries, Inc.: Positronic Industries, Inc.®, Positronic®, Connector Excellence®, P+ logo®, PosiBand®, PosiShop®, Optik-D™, and The Science of Certainty®. The color blue as it appears on various connectors is a trademark of Positronic Industries, Inc., Registered in U.S. Patent and Trademark Office.

Products described within this catalog may be protected by one or more of the following US patents:

- #4,9000,261 #5,255,580 #5,329,697
- #7,115,002 #8,944,697 #9,304,263

Patented in Canada, 1992 Other patents pending

Positronic | Americas

423 N Campbell Ave
Springfield MO 65806 USA
+1 800 641 4054
info@connectpositronic.com

Positronic | Europe

46 route d'Engachies
F-32020 Auch Cedex 9 France
+33 5 6263 4491
contact@connectpositronic.com

Positronic | Asia

3014A Ubi Rd 1 #07-01
Singapore 408703
+65 6842 1419
singapore@connectpositronic.com

Sales Offices

Positronic has local sales representation all over the world. For the nearest sales office visit www.connectpositronic.com/sales